

Application

Designed for installation on potable water lines to protect against both backsiphonage and backpressure of polluted water into the potable water supply. The Model 350 shall provide protection where a potential health hazard does not exist. Ideal for use where lead-free* valves are required.



Standards Compliance : (Sizes 2 1/2"-10" Horiz. & Vert.)
(Size 12" horizontal)

- ASSE® Listed 1015
- CSA® Certified
- IAPMO® Listed
- Certified to NSF/ANSI 372* by IAPMO R&T
- AWWA Compliant C510, and C550
- UL® Classified
- C-UL® Classified
- FM® Approved (2 1/2" - 10")
- Approved by the Foundation for Cross Connection Control and Hydraulic Research at the University of Southern California
- NYC MEA 50-01-M (2 1/2" - 3")
- NYC MEA 297-98-M (4" - 6")
- NYC MEA 316-01-M (8" - 10")
- NSF® Listed-Standard 61, Annex G*

*(0.25% MAX. WEIGHTED AVERAGE LEAD CONTENT)

Materials

Main valve body	Ductile Iron ASTM A 536 Grade 4
Access covers	Ductile Iron ASTM A 536 Grade 4
Coatings	FDA Approved fusion epoxy finish
Internals	Stainless steel, 300 Series NORYL™, NSF Listed
Fasteners	Stainless Steel, 300 Series
Seal ring	EPDM (FDA approved)
O-ring	Buna Nitrile (FDA approved)
Springs	Stainless Steel, 300 Series

Features

Sizes:	2 1/2", 3", 4", 6", 8", 10", 12"
Maximum working water pressure	175 PSI
Maximum working water temperature	140°F
Hydrostatic test pressure	350 PSI
End connections	
	(Grooved for steel pipe) AWWA C606
	(Flanged) ANSI B16.1
	Class 125

Options

(Suffixes can be combined)

- with NRS shut-off valves (standard)
- FS - with cast iron wye type strainer (flanged only 2-1/2"-10")
- FSC - with epoxy coated wye type strainer (flanged only 2-1/2"-10")
- G - with groove end gate valves (2-1/2" - 10")
- GF - with grooved inlet gate connection and flanged outlet gate connection (2-1/2" - 10")
- FG - with flanged inlet gate connection and grooved outlet gate connection (2-1/2" - 10")
- L - less shut-off valves (flanged body connections)
- OSY - with OS & Y gate valves
- PI - Post Indicator gate Valve (3"-12")
- DOM - with Clow gate valves, 51% Buy American Act Compliant

Accessories

- Repair kit (rubber only)
- Thermal expansion tank (Model XT)
- OS & Y Gate valve tamper switch (OSY-40)
- Test Cock Lock (Model TCL24)

Attention: Model 350 (flange body) and 350A (grooved body) have different lay lengths.

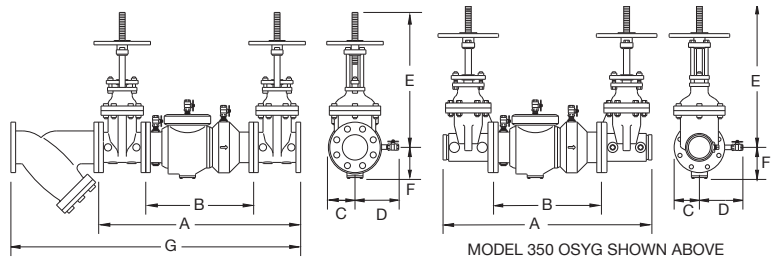

Dimensions & Weights (do not include pkg.)

SIZE	DIMENSION (approximate)																WEIGHT								
	A		B LESS GATE VALVES		C		D		E OS&Y OPEN		E OS&Y CLOSED		E NRS GATE		F		G		WITHOUT GATES VALVES		WITH NRS GATE VALVES		WITH OS&Y GATE VALVES		
	in.	mm	in.	mm	in.	mm	in.	mm	in.	mm	in.	mm	in.	mm	in.	mm	in.	mm	lbs.	kg	lbs.	kg	lbs.	kg	
2 1/2	65	31	791	15 7/8	403	3 3/4	95	7 1/4	184	16 3/8	416	13 7/8	352	11 3/8	289	3 1/2	89	41 1/4	1048	53	24.1	155	70.4	163	74
3	80	32	816	15 7/8	403	3 3/4	95	7 1/4	184	18 7/8	479	15 5/8	397	12 3/8	314	3 1/2	89	42 3/4	1086	53	24.1	177	80.4	183	83
4	100	37 5/8	956	19 1/2	495	4 1/2	114	8	203	22 3/4	578	18 1/4	464	14 3/4	375	6	152	52 3/4	1340	91	41.3	271	123	281	127.6
6	150	44 3/4	1137	23 1/2	597	6	152	10	254	30 1/8	765	23 3/4	603	19	483	7	178	62 3/4	1594	165	74.9	449	203.8	465	211
8	200	60 3/4	1543	37 3/4	959	10	254	11	279	37 3/4	959	29 1/4	743	22 1/2	572	8 1/2	216	85	2159	358	162.5	810	367.7	834	378.6
10	250	63 3/4	1619	37 3/4	959	10	254	11	279	45 3/4	1162	35 3/8	899	26 1/2	673	8 1/2	216	93 1/4	2369	388	176.2	1148	521.2	1206	547.5
12	300	66 1/4	1683	38	965	10	254	12	305	53 1/8	1349	40 5/8	1032	30	762	9	229	n/a	n/a	447	202.8	1493	677.2	1607	729

MODEL 350 2 1/2", 3" & 4" (STANDARD & METRIC)

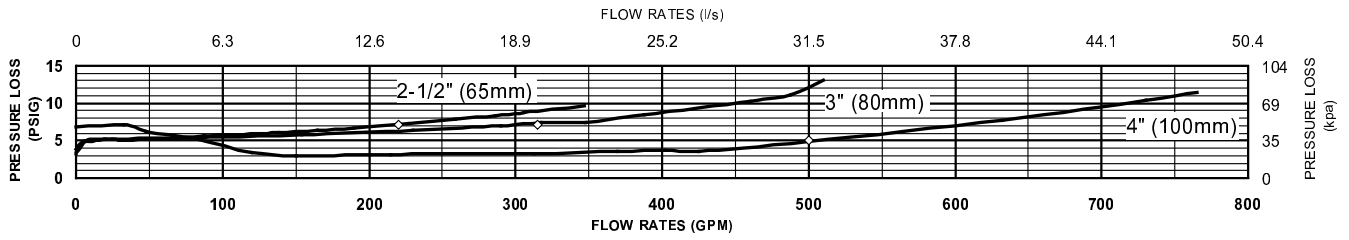

MODEL 350 6" & 8" (STANDARD & METRIC)

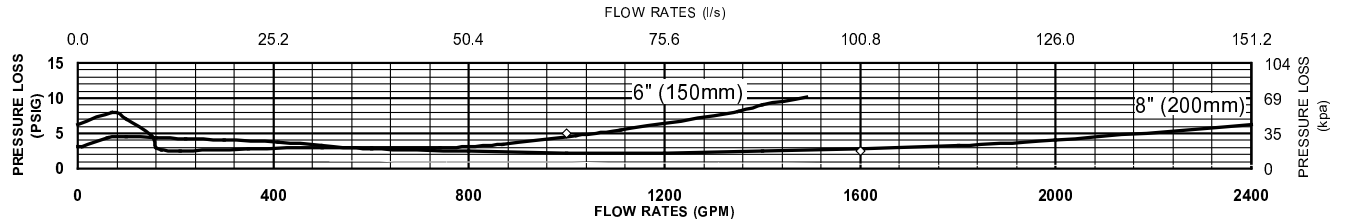

MODEL 350 10" & 12" (STANDARD & METRIC)

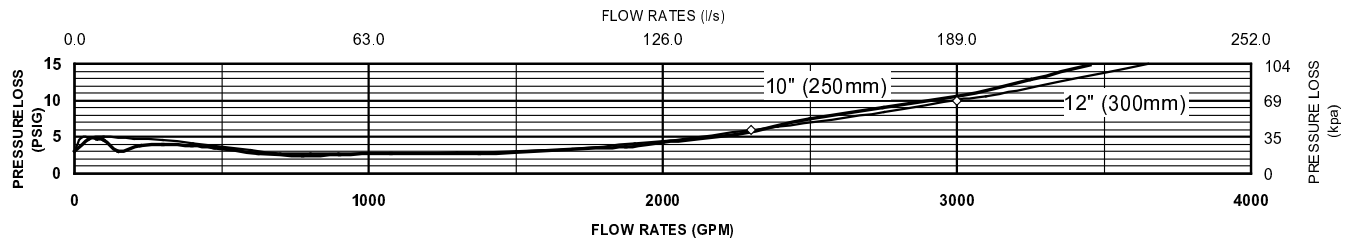

Typical Installation

Local codes shall govern installation requirements. Unless otherwise specified, the assembly shall be mounted at a minimum of 12" (305mm) and a maximum of 30" (762mm) above adequate drains with sufficient side clearance for testing and maintenance. The installation shall be made so that no part of the unit can be submerged.

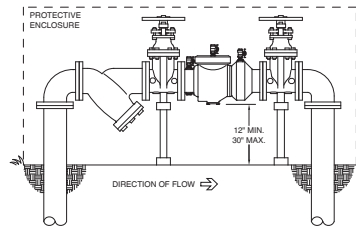

OUTDOOR INSTALLATION

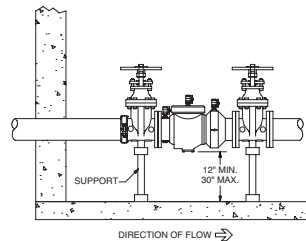

INDOOR INSTALLATION
(350GF)

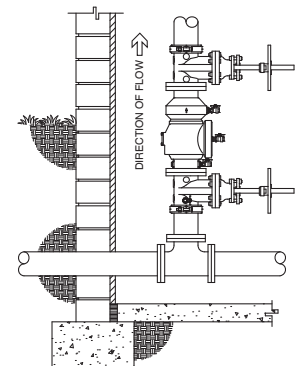

VERTICAL INSTALLATION
(350G)

Capacity thru Schedule 40 Pipe (GPM)				
Pipe size	5 ft/sec	7.5 ft/sec	10 ft/sec	15 ft/sec
2 1/2"	75	112	149	224
3"	115	173	230	346
4"	198	298	397	595
6"	450	675	900	1351
8"	780	1169	1559	2339
10"	1229	1843	2458	3687
12"	1763	2644	3525	5288

Specifications

The Double Check Backflow Prevention Assembly shall be certified to NSF/ANSI 372, ASSE® Listed 1015, and supplied with full port gate valves. The main body and access cover shall be epoxy coated ductile iron (ASTM A 536 Grade 4), the seat ring and check valve shall be NORYL™, the stem shall be stainless steel (ASTM A 276) and the seat disc elastomers shall be EPDM. The checks shall be accessible for maintenance without removing the device from the line. The Double Check Backflow Prevention Assembly shall be a ZURN WILKINS Model 350.